

ESCALATOR



U
series

Committed to Unparalleled Excellence for People, Society, and the Environment.

- To keep our promise to deliver security and comfort...
- To pursue products that are more aesthetic, safer, and easier to use...
- To introduce new values expected for escalators to a wider variety of spaces...
- U Series escalators are leading the way with an extensive range of technologies.



Contents

Universal	3-4
Ecology	5
Flexibility / Availability	6
Designs	7-8
Safety Devices	9
Cautions for Outdoor Use	10
Product Data	11-12
Work Not Included in Escalator Contract	13
Quality in Motion	14

Safety Specifications for All

Secure boarding / exiting for the elderly

Elderly people and children can fall when they get on or off an escalator because their steps are small, and they have difficulty in stepping on or off the steps moving fast. Operating the escalators at lower speed ensures a safe and comfortable ride for all passengers.

Energy-saving mode*1 Standard

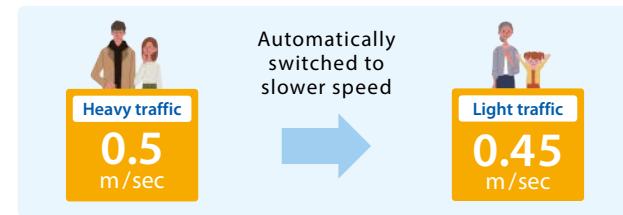

Manually switched to slower speed

Variable-speed operation*1 Optional

The escalator speed can be reduced using the key switch³, for example, when the escalator is frequently used by elderly people, or when the escalator runs in downward direction as passengers can feel nervous about getting it on safely.

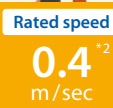

Rated speed 0.4 m/sec²

Secure, gentle stop at the time of an emergency

The sudden stop triggered by the emergency stop button or other safety devices can cause passengers to lose their balance and fall. This function stops the escalator gently⁴ to prevent the passengers from falling. Safety can be further enhanced by the mechanical structure that stops the escalator gently in case of power outage.⁵



Sterilized for comfortable and safe ride

Handrail sterilizer Optional^{*6}

The sterilizer continuously emits UV light to remove bacteria from the handrails while the escalator is running.



Specifications to Prevent Unlikely Events

Protection against falling by stepping on the deck board

The deck boards are ergonomically set at a height that makes it more difficult for passengers to put their feet on them, in order to discourage passengers from standing on them.

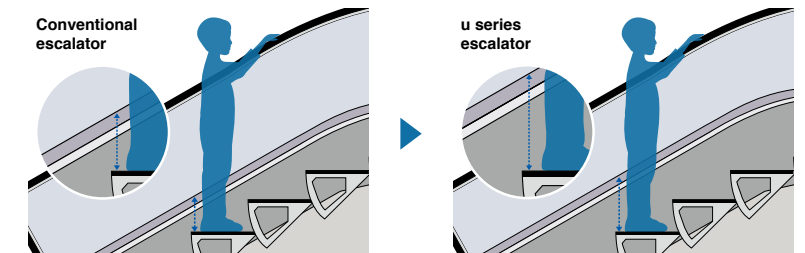

The height of the deck boards of u series makes it more difficult to stand on them compared with the conventional escalators.

Protection against entrapment of sandals and clothing

Yellow demarcation lines on the step edges, tiered demarcation lines on both sides of the steps and skirt brushes guide passengers to stand away from the sides to prevent passengers' shoes or clothes from getting caught. A special coating on the skirt guards reduces friction to minimize the risk.



Tiered demarcation line Standard



Skirt brush Optional

Secure, easy boarding / exiting

We have made the comb teeth at a 10° angle to keep passengers from tripping at landing areas. Improved visibility on the boundaries between moving and stationary parts and between steps ensures passenger safety. Further, three horizontal steps help passengers safely get on or off the escalator.



Comb with smaller angle Standard



Comb light Optional

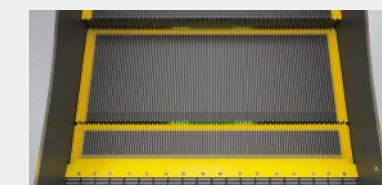

Step demarcation lighting Optional



Three horizontal steps Optional

Notes:

- *1: The escalator does not go into energy-saving mode (operation during light traffic) when it is in variable-speed operation.
- *2: The speed can be set at your desired speed.
- *3: The switch to be installed on the skirt guard at a landing area is optional. If the switch is not installed, a technician can switch the speed by operating the control panel.
- *4: If any safety device that detects entrapment is activated, the escalator stops instantly. The escalator stops slowly or instantly depending on the activated safety device.
- *5: Slow-stop feature in case of power outage is optional.
- *6: Please consult our local agents whenever you require this device.

Ecology

Kinder Environmental Performance

Substantial energy savings achieved through efficient use of energy improves building value.

Innovative inverter control Standard

An inverter with optimum VVVF control technology that increases motor efficiency under light loads is provided as standard equipment, for improved energy efficiency.

Energy-saving mode combined with automatic operation – slow operation in stand-by Standard

This operation mode controls the travel speed depending on the passenger traffic volume detected by the sensor. This mode saves energy without compromising riding comfort. The escalator runs at 0.2m/sec when no passengers are on the steps, and gently accelerates when the sensors detect a passenger. The travel direction is readily apparent to approaching users.

Energy savings: Approx. 30% *1	Power conserved: Approx. 2,100 kWh/year *1	CO ₂ emissions reduction: Approx. 1.3 t/year *1
--	--	--

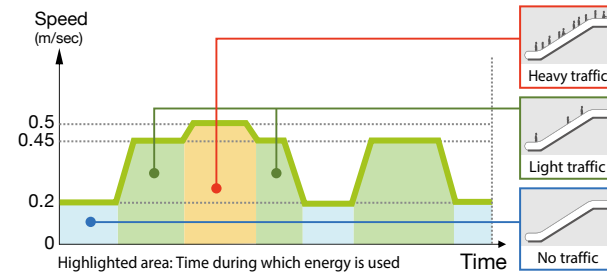

Energy-saving mode combined with automatic operation – stationary in stand-by*2*3 Optional

The escalator stops when no passengers are on the steps. When the sensors detect a passenger, the escalator gently accelerates to the rated speed.

Energy savings: Approx. 40% *1	Power conserved: Approx. 2,800 kWh/year *1	CO ₂ emissions reduction: Approx. 1.7 t/year *1
--	--	--

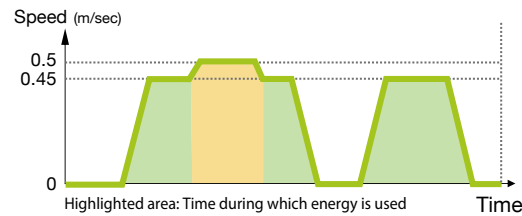

Passenger sensors (for automatic operation)

Passenger sensors detect the passenger traffic. Postless- and post-type sensors are available for passenger detection.

Postless type

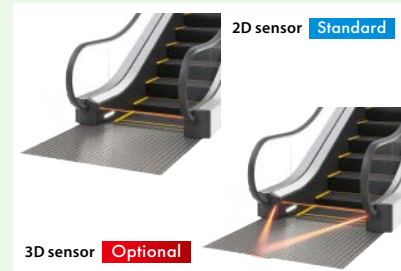

Post type Optional



*The orange beams are the image of infrared light. The actual beams are not visible.

Regenerative converter Standard

The regenerative converter has the effect of reducing energy consumption by transmitting the power generated when the escalator runs downward with a certain passenger load or more to other facilities in the building.

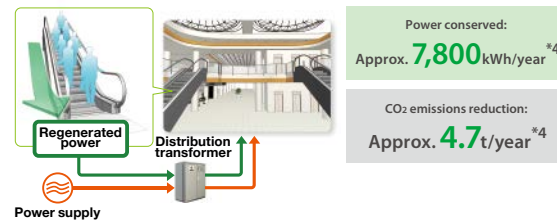

Power conserved: Approx. 7,800 kWh/year *4
CO ₂ emissions reduction: Approx. 4.7 t/year *4

LED lighting LED

Using long-lasting, low power consumption LED lights for all lighting options (under-handrail lighting, skirt guard lighting, comb lights and step demarcation lighting) reduces power consumption by approximately 75% compared to fluorescent lights.

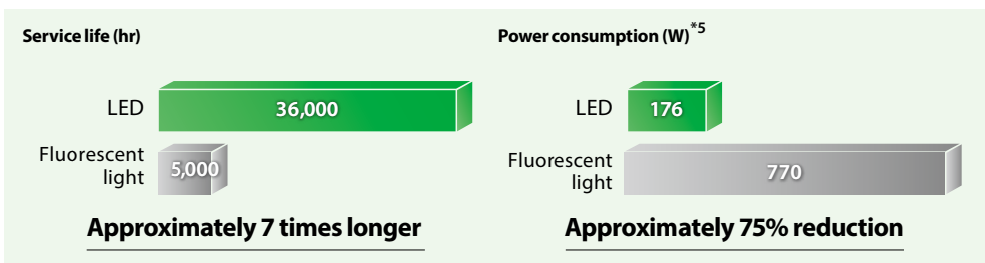

Notes:
*1: Compared with existing Z-series escalators which are not equipped with an inverter. Calculated on the basis of the following conditions: Type S1000, rise of 5m, traffic of 100 passengers/hour, standby period of 30 min/hour, speed of 0.5m/sec, 12 hours/day and 365 days/year operation, CO₂ conversion rate of 0.6kg/kWh. The amounts of power conservation and CO₂ emissions reduction vary depending on the traffic volume and building specifications.
*2: Direction indicators or signage (by owner) are required.
*3: This operation can be combined with slow operation in stand-by. (Optional)
*4: Compared with escalators which are not equipped with a regenerative converter and are in downward operation. Calculated on the basis of the following conditions: Type S1000, rise of 5m, load rate of 40%, downward operation, speed of 0.5m/sec, 12 hours/day and 365 days/year operation, CO₂ conversion rate of 0.6kg/kWh. The amounts of power conservation and CO₂ emissions reduction vary depending on the traffic volume and building specifications.
*5: Calculated on the basis of the following conditions: Rise of 5m, equipped with under-handrail lighting, comb lights and step demarcation lighting.

Flexibility

Kinder Architectural Design

Industry-leading compact, lightweight design enhances the flexibility in architectural design.

Higher degree of freedom in architectural design achieved through “the industry-leading compact escalator”¹ and “substantial reduction in weight (25% lighter than our previous models)”

By optimizing the equipment space, we have achieved an industry’s shortest escalator length. We have employed a structural optimization (topology) tool to minimize the amount of materials used, thus enabling reduction in truss weight by 25% compared to conventional escalators while maintaining the same level of structural strength. The compact and reduced weight truss makes it easy to install and provides architectural flexibility to your building design.

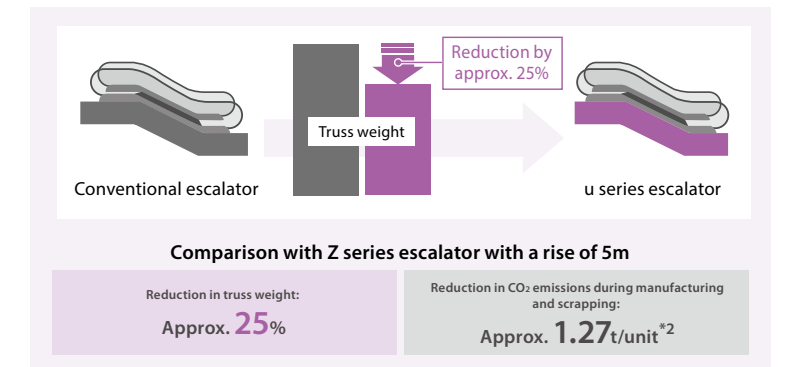
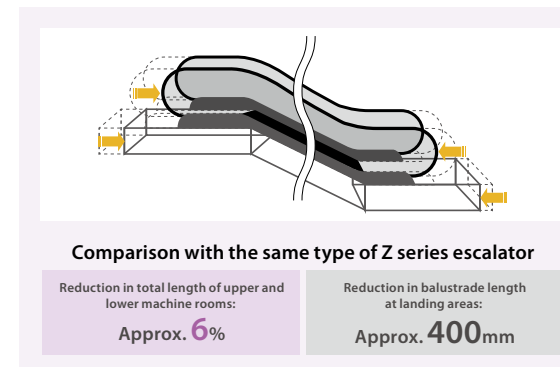

Notes:
*1: Target model is Type S1000. Based on in-house research as of October 2020.
*2: Iron ores are refined in the blast furnace (2.3 ton of CO₂ emissions/1 ton of iron). CO₂ emissions during transport of iron ores and scrapped products to a steelworks are not included. (Based on in-house research)

Availability

Kinder Preventive Maintenance

Downtime minimized through proven achievements in Mitsubishi Electric product quality and preventive maintenance technologies.

Downtime minimized by displaying “warnings for changing service parts” and “fault indication”

If a fault occurs on the escalator, the fault indicator indicates the location of the fault to enable quick maintenance. In addition, the indicator indicates the service parts that are nearing the end of the service life by verifying the data on accumulated operating hours and the maintenance record with the service life of the parts. This allows technicians to prepare the spare parts, minimizing the escalator downtime for maintenance.

Displays service parts on the control panel Standard

Example of service parts to display

Displays operating status on the indicator at landing area Optional

In service (speed displayed): 5.0 (0.5m/sec)

Stopped (fault code displayed): E.1 (Stoppage reason: HGS*)

Stopped (fault code displayed): E.2 (Stoppage reason: CRS*)

*See page 9 for safety devices.

Remote monitoring system – MelEye Optional

MelEye allows you to continuously monitor the operational status of your escalators from a single computer. It immediately notifies the building manager of problems that occur.

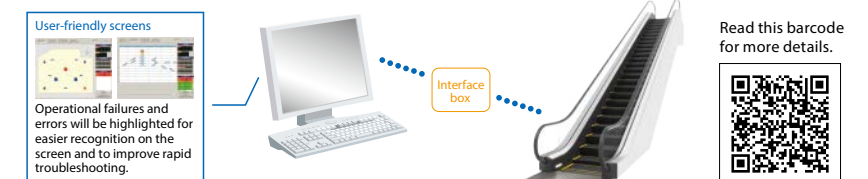

Designs

Kinder Designs Blend into Buildings

A diverse product lineup offers aesthetic effects for building transportation modes and more.

Model



Glass Panel

Glass Panel with Under-handrail Lighting **LED**

Stainless-steel Panel

Step demarcation lines



Yellow painted **Standard**



Yellow plastic **Optional**

Skirt guard

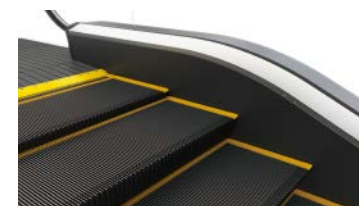

Low-friction black paint finish **Standard**

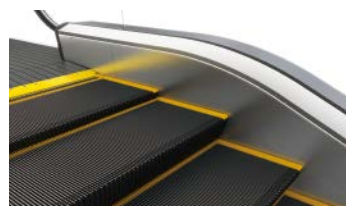

Stainless-steel, hairline finish **Optional**

Comb

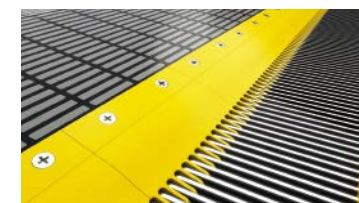

Yellow plastic **Standard**



Aluminum **Optional**

Floor plate

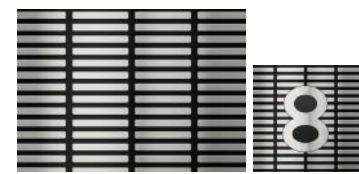

Embossed stainless-steel plate with black grooves **Standard** **Optional**

Notes:

*1: The lighting is not applicable to outdoor use. Under-handrail lighting cannot be combined with skirt guard lighting.

*2: The sensor posts for automatic operation are available in stainless-steel hairline finish or stainless-steel mirror finish.

Deck board



Stainless-steel, hairline finish **Standard**

Lighting **LED**

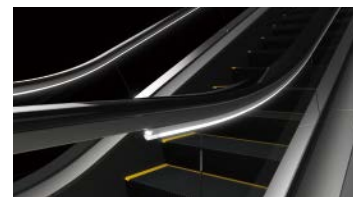

Under-handrail lighting*1 **Optional**



Skirt guard lighting*1 **Optional**



Comb lights **Optional**



Step demarcation lighting **Optional**

Sensor post for automatic operation*2 **LED**



Optional

Direction indicator **LED**

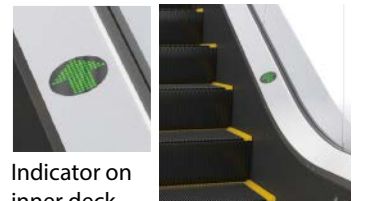

Indicator on inner deck **Optional**

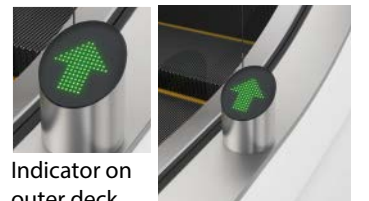

Indicator on outer deck **Optional**

Handrail

Rubber Antibacterial polyurethane Polyurethane handrails are highly resistant to dirt and create a shiny and brighter look.

Black Red Vermilion Yellow Green Blue Light gray Warm gray Brown Mild black Black

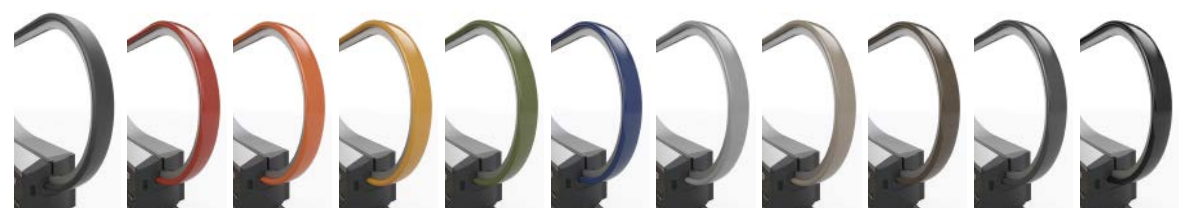

Standard **Optional**

Safety Devices

Various safety devices ensuring high levels of safety and reliability.

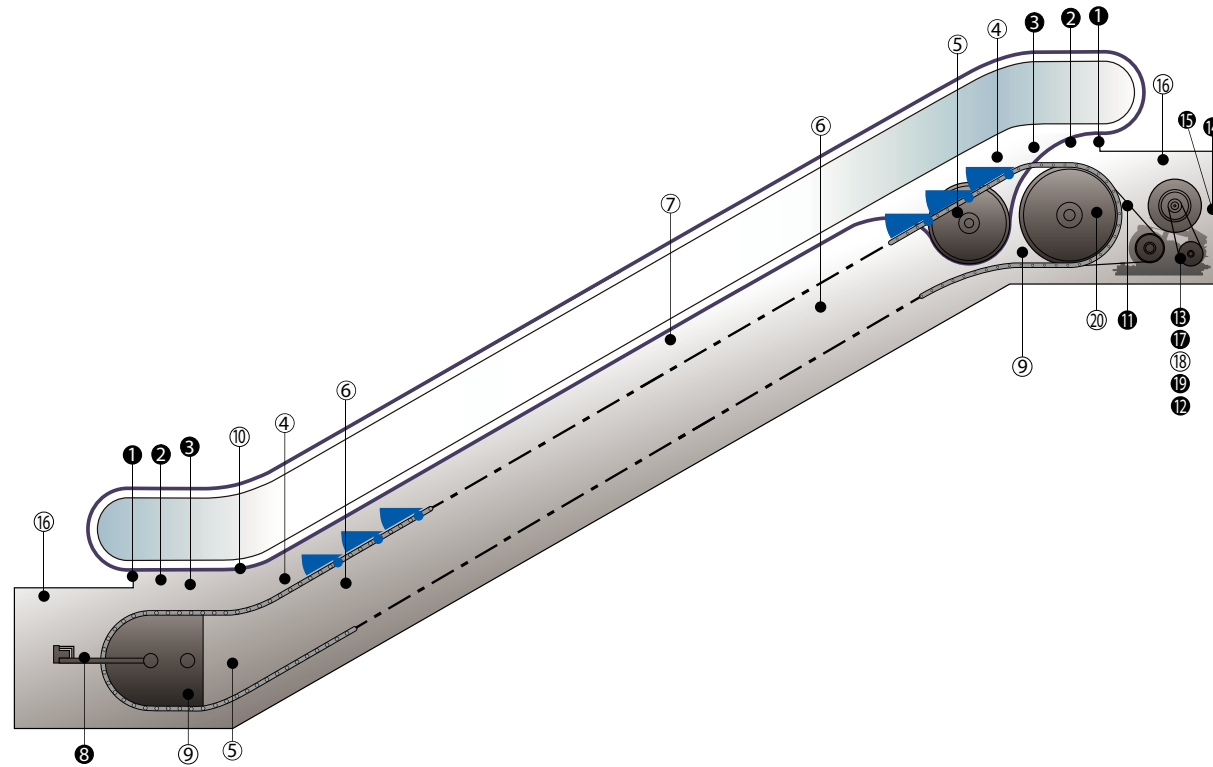

●: Standard, ○: Optional

Safety device	Description	Application
1 Handrail Guard Safety Device (HGS)	1) Inlet guard Made of soft rubber, which fits over the outside of the handrail where it enters the balustrade, and keeps fingers, hands or foreign objects away from the handrail opening. 2) Inlet guard switch Stops the escalator when physical contact is made with the inlet.	●
2 Emergency Stop Button (E-STOP)	Stops the escalator in emergency situations.	●
3 Comb-step Safety Switch (CSS)	Stops the escalator if a foreign object becomes trapped in the gap between the step and comb.	●
4 Skirt Guard Safety Device (SSS)	Stops the escalator if a shoe or other item becomes trapped in the gap between the step and skirt guard.	○
5 Step Motion Safety Device (CRS)	Stops the escalator when a step has been dislocated on its riser side because of an object caught between the steps, or between the skirt guard and the step, or if an abnormality has been observed in the step motion.	○
6 Step Level Device (SRS)	Stops the escalator if the horizontal level of a step has dropped.	○
7 Skirt Brush	Prevents passengers' shoes or clothes from getting caught between steps and skirt guards.	○
8 Step Chain Safety Device (SCS)	Stops the escalator if the step chain breaks or stretches beyond an allowable limit.	●
9 Missing Step Device (SMS)	Stops the escalator if it detects a missing step(s) before it is visible to passengers.	○
10 Handrail Speed Safety Device (HSS)	Stops the escalator if the handrails fail to synchronize with the steps because of slippage, loosening or breakage of the handrails.	○
11 Drive Chain Safety Device (DCS)	Stops the escalator if the drive chain breaks or stretches beyond an allowable limit.	●
12 Speed Governor (GOV)	Stops the escalator before the operating speed exceeds the rated speed or if the operation speed becomes unusually slow.	●
13 Electromagnetic Brake	Stops the escalator in case of power failure, or if any safety device or the emergency stop button has been activated.	●
14 Overload Detection Device	Stops the escalator if overload has been detected.	●
15 Three Elements (3E)	Stops the escalator if any of the three abnormal conditions is detected: open phase (wire breakage), phase reversal or overload.	●
16 Door Open Switch (DOS)	Stops the escalator when the floor plate is opened.	○
17 Slow-stop – Type 1 (electrical slow stop by inverter)	Slowly stops the escalator to prevent passengers from falling if a safety device or the emergency stop button has been activated. (If any safety device that detects entrapment is activated, the escalator stops instantly.)	●
18 Slow-stop – Type 2 (electrical slow stop by inverter combined with mechanical slow stop)	Not only slowly stops the escalator by inverter control, but also slowly stops the escalator by mechanical structure to prevent passengers from falling in case of power failure.	○
19 Excess Stop Distance Detection (ESD)	Checks that there is no abnormality in the stopping distance when the escalator stops.	●
20 Auxiliary Brake	Stops the escalator if the speed exceeds the rated speed, or before the steps' traveling direction changes due to an abnormality such as breakage of the drive chain.	○

Cautions for Outdoor Use

A roof must be provided over outdoor escalators. In rainy weather without a roof, passengers are in great danger of having their umbrellas blown away by the wind or falling down on the slippery steps. In hot weather, the handrails and deck boards can easily heat up in the sun to a surface temperature exceeding 50°C, causing the unnecessary chance that passengers could get burnt on the overheated elements. In addition, when not covered by a roof, the life and performance of outdoor escalators seriously deteriorate, leading to shorter product life and higher cost for maintenance.

1. How to define outdoor escalators

Escalators are classified into three categories: outdoor, semi-outdoor and indoor. Outdoor escalators are defined as escalators exposed to environmental factors such as wind, rain, snow or direct sunlight.

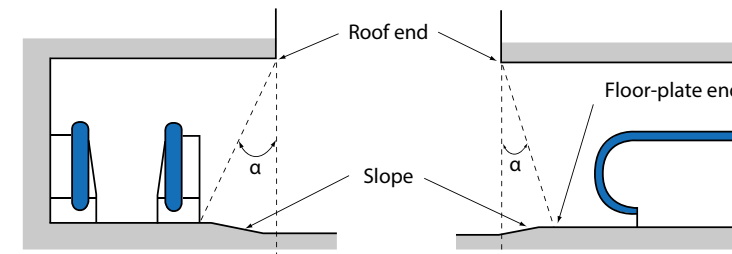

Indoor	$\alpha > 70^\circ$
Semi-outdoor	$30^\circ \leq \alpha \leq 70^\circ$
Outdoor	$\alpha < 30^\circ$

Angle α in the illustration varies depending on the direction in which the escalator is viewed. Check how the angle varies, take the smallest angle, apply it to the table above and determine the escalator type.

2. Environmental requirements for outdoor escalators

Permissible ambient temperature	Minimum	-10°C (Special measures are required in cold districts where the ambient temperature can drop below -10°C.)
	For escalator operation	0°C to less than 40°C
Wind pressure	Escalators must not be exposed to direct wind pressure outside the following ranges: 490N/m ² or less on the windward side, 245N/m ² or less on the leeward side	
Others	Measures are required for escalators installed within a radius of 2 km from a shore to protect them from direct exposure to salty wind.	

3. Architectural requirements for outdoor escalators

- Intermediate support beams must be provided.
- The level of the escalator floor plate must be higher than the floor finish of the building to minimize the chance of rain or cleaning water running into the escalator truss. Area (B) in the illustrations to the right must be at a slope of at least 10°, and the surface of (A) must be horizontal to minimize the risk of passengers stumbling.
- Drainage must be provided in the entire area marked (C) and covered with grating to keep away drain water.
- The escalator pit must be waterproofed entirely when a whole truss is installed inside the pit. In addition, the upper pit floor must be sloped towards the lower floor to let any water in the pit drain out and down.
- If there is a chance of the lower machine room getting flooded, drainage equipment, such as a drain pump, must be provided to discharge any water.
- Water in the lower pit will contain lubrication oil, so a grease trap should be provided to separate the lubrication oil from the water. The capacity of the grease trap is determined according to the escalator size and maximum amount of expected rainfall.
- Water may drip from the exterior panels of the escalator. Take waterproofing measures for equipment or items under the exterior panels if water is likely to cause problems or accidents.

Detailed floor plan for outdoor escalators

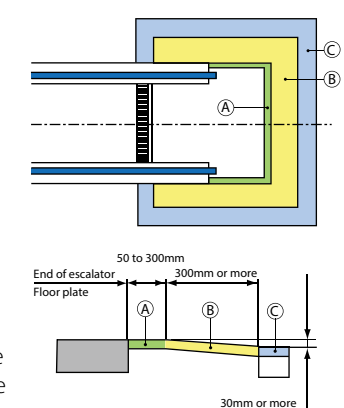

Product Data

Mitsubishi Electric Standard Specification *1

Basic Data

Max. rise	30°: 9000mm, 35°: 6000mm	Control system	VVVF inverter
Inclination	30°, 35°	Environment ²	Indoor (Standard), semi-outdoor or outdoor (Optional)
Horizontal steps	30°: 1.5 steps (Standard), 2 or 3 steps (Optional)	Step width	Type S600: 604mm, Type S800: 804mm, Type S1000: 1004mm
	35°: 2 steps (Standard), 3 steps (Optional)		Theoretical transport capacity ³
Handrail height	Landing areas: 900mm, Inclined area: 790mm (Standard)	Type S600: 4500 persons/hr	Type S800: 6750 persons/hr
	Landing areas: 1000mm, Inclined area: 876mm (Optional)	Type S1000: 9000 persons/hr	
Rated speed	0.5m/sec (Standard), 0.45, 0.4 or 0.35m/sec (Optional)		

Sections of the balustrade

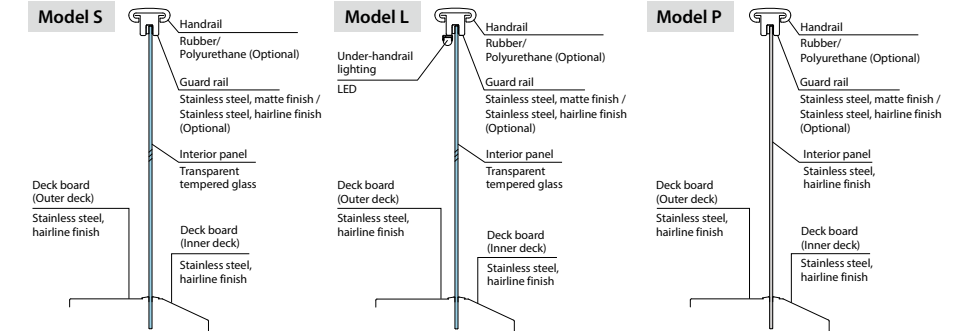

Layout

30°

(Unit: mm)

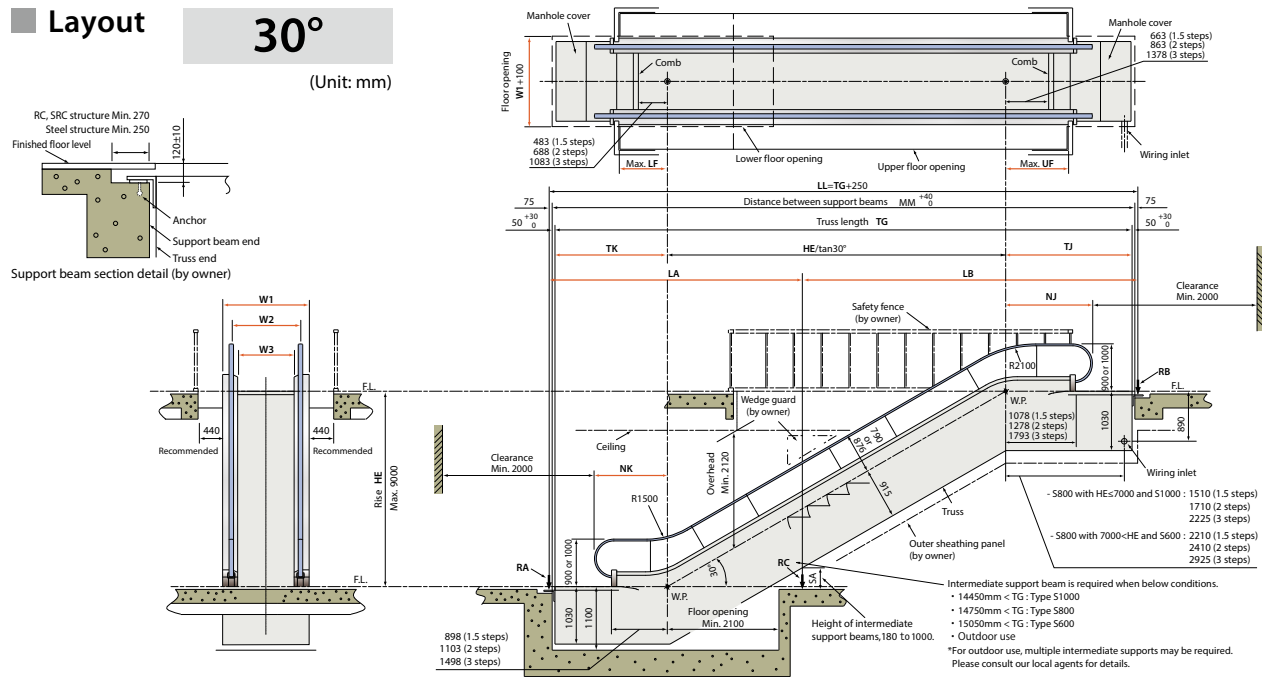

35°

(Unit: mm)

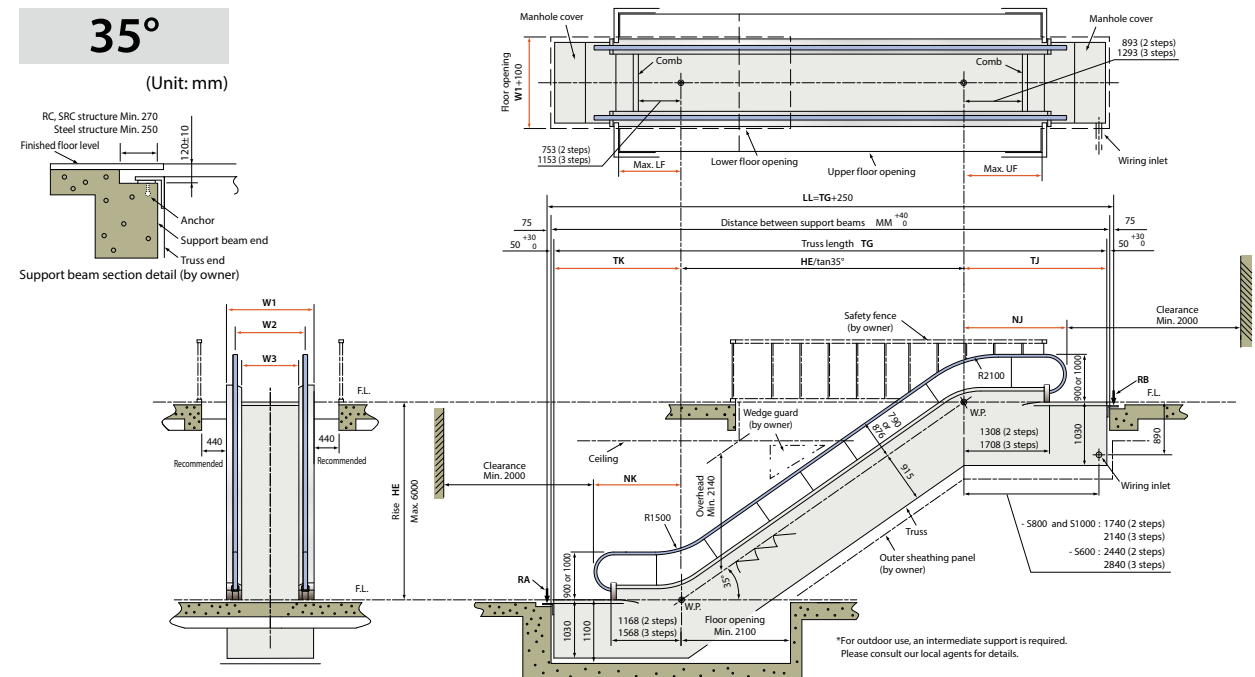

Table 1: Standard dimensions

Width	Type		
	S600	S800	S1000
W1 (escalator width)	1150	1350	1550
W2 (between moving handrails)	840	1040	1240
W3 (between skirt panels)	610	810	1010

Type	Max. LA, LB Environment	
	Indoor / Semi-outdoor	Outdoor
S1000	11000	10000
S800		
S600	11700	

Horizontal steps	Type	TJ		TK	NJ	NK	UF	LF
		HE≤7000	7000<HE					
1.5 steps (nominal)	S1000	2110	2310	1930	1400 (1445)	1220 (1265)	928	748
	S800	2210	2410					
2 steps	S600	2410	2410	2135	1600 (1645)	1425 (1470)	1128	948
	S1000	2310	2510					
	S800	2410	2610					
3 steps	S600	2610	2610	2530	2115 (2160)	1820 (1865)	1643	1348
	S1000	2825	3025					
	S800	2925	3125					
	S600	3125	3125					

*The dimensions in parentheses are for an escalator with a handrail height at landing areas of 1000mm, and other dimensions are for one with a handrail height at landing areas of 900mm.

Table 2: Loads (N)

	Without intermediate support beam	With intermediate support beam
RA	$\alpha \cdot LL + \frac{\beta_1 \cdot (LL-L1) + \beta_2 \cdot L2}{LL}$	$\alpha \cdot LA + \beta_1 \cdot \frac{\beta_1 \cdot L1}{LA}$
RB	$\alpha \cdot LL + \frac{\beta_1 \cdot L1 + \beta_2 \cdot (LL-L2)}{LL}$	$\alpha \cdot LB + \beta_2 \cdot \frac{\beta_2 \cdot L2}{LB}$
RC	—	$\alpha \cdot LL + \frac{\beta_1 \cdot L1}{LA} + \frac{\beta_2 \cdot L2}{LB}$

$\beta_1, \beta_2, L1, L2$

Horizontal steps	β_1	β_2	L1	L2
1.5 steps (nominal)	3500	11000	TK-704	TJ-873
2 steps			TK-909	TJ-1073
3 steps			TK-1304	TJ-1588

Factors α

Type	TG	α (N/mm)	
		Indoor / Semi-outdoor	Outdoor
S1000	TG ≤ 12700	3.68	3.68
	12700 < TG ≤ 14450	3.75	
	14450 < TG	3.68	
S800	TG ≤ 13325	3.33	3.33
	13325 < TG ≤ 14750	3.39	
	14750 < TG	3.33	
S600	TG ≤ 13950	2.96	2.96
	13950 < TG ≤ 15050	3.03	
	15050 < TG	2.96	

Table 1: Standard dimensions

Width	Type		
	S600	S800	S1000
W1 (escalator width)	1150	1350	1550
W2 (between moving handrails)	840	1040	1240
W3 (between skirt panels)	610	810	1010

Horizontal steps	Type	TJ	TK	NJ	NK	UF	LF
2 steps	S1000	2340	2200	1630 (1675)	1490 (1535)	1158	1018
	S800	2440					
	S600	2640					
3 steps	S1000	2740	2600	2030 (2075)	1890 (1935)	1558	1418
	S800	2840					
	S600	3040					

*The dimensions in parentheses are for an escalator with a handrail height at landing areas of 1000mm, and other dimensions are for one with a handrail height at landing areas of 900mm.

Table 2: Loads (N)

	Without intermediate support beam
RA	$\alpha \cdot LL + \frac{\beta_1 \cdot (LL-L1) + \beta_2 \cdot L2}{LL}$
RB	$\alpha \cdot LL + \frac{\beta_1 \cdot L1 + \beta_2 \cdot (LL-L2)}{LL}$

$\beta_1, \beta_2, L1, L2$

Horizontal steps	β_1	β_2	L1	L2
			2 steps	3500
3 steps			TK-1374	TJ-1503

Factors α

Type	TG	α (N/mm)	
		Indoor / Semi-outdoor	Outdoor
S1000	TG ≤ 12700	3.68	3.68
	12700 < TG ≤ 13950	3.75	
	13950 < TG	3.68	
S800	TG ≤ 13325	3.33	3.33
	13325 < TG ≤ 14500	3.39	
	14500 < TG	3.33	
S600	TG ≤ 13950	2.96	2.96
	13950 < TG ≤ 15050	3.03	
	15050 < TG	2.96	

Notes:

*1: Based on, but not fully complying with the Building Standard Law of Japan, 2009.

*2: See page 10 for details.

*3: These are theoretical values of an escalator with a rated speed of 0.5m/sec. If the traffic volume at peak periods exceeds the following, more powerful equipment is required to meet heavy traffic demands.

Type S600: 500 persons per 10 minutes

Type S800: 750 persons per 10 minutes

Type S1000: 1000 persons per 10 minutes

Please consult our local agents for details.

Work Not Included in Escalator Contract

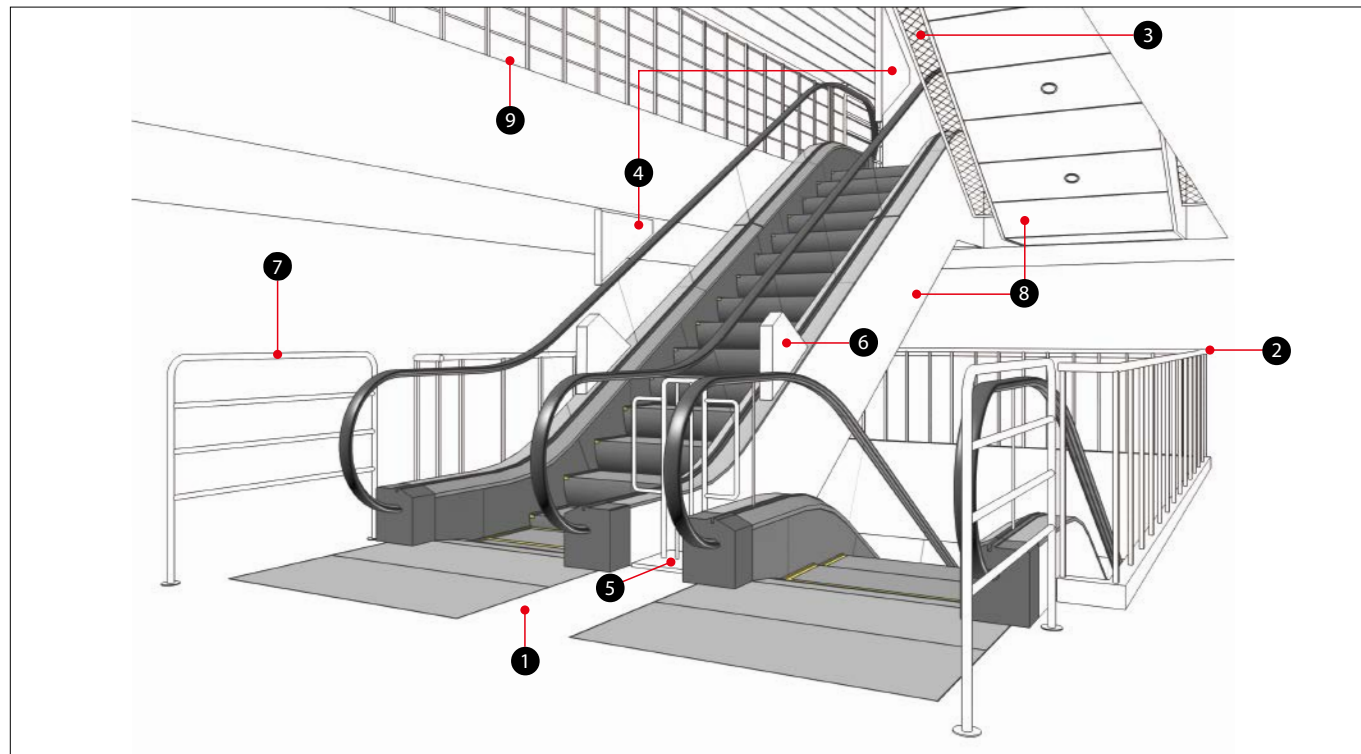

The following items are excluded from our escalator installation work and are therefore the responsibility of the building owner or general contractor. Safety measures shall be provided in accordance with the local laws and standards.

■ Architectural work

1. Installation of support beams (including intermediate supports)
2. Hole filling and floor finishing in surrounding areas after escalator installation (1)
3. Fireproofing and fire-prevention measures for escalator exterior materials and surrounding areas
4. Safety features for surrounding areas
 - Safety fences (2)
 - Nets (3)
 - Wedge guard (4)
 - Deck guards (5)
 - Deck barricades (6)
 - Guiding fences (7)
5. Outer panel sheathing (8)
6. Installation of inspection doors

■ Facility work

1. Conduit and wiring work for power supply to control panel in upper truss, power supply for lighting and grounding
2. Other wiring and conduit work
3. Installation of outlets in the upper and lower trusses
4. Installation of fire-prevention shutters (9)

Notes on building work

1. Tolerance in distance between supporting beams: +40mm to 0
2. Flooring around the escalator must not be finished until the escalator is installed.
3. Flooring within 300mm " of the escalator floor plate must not be finished until the floor plates are in place.
4. Sprinkler pipes or wiring for soffit lights, or any other electric conduits for items other than escalator, must not be laid inside the truss.
5. No walls or other parts of the building structure must be supported on the truss.
6. Allowable maximum weight of outer sheathing: 20kg/m²

Principle

Based on our policy, "Quality in Motion", we provide elevators and escalators that will satisfy our customers with high levels of comfort, efficiency, ecology and safety.

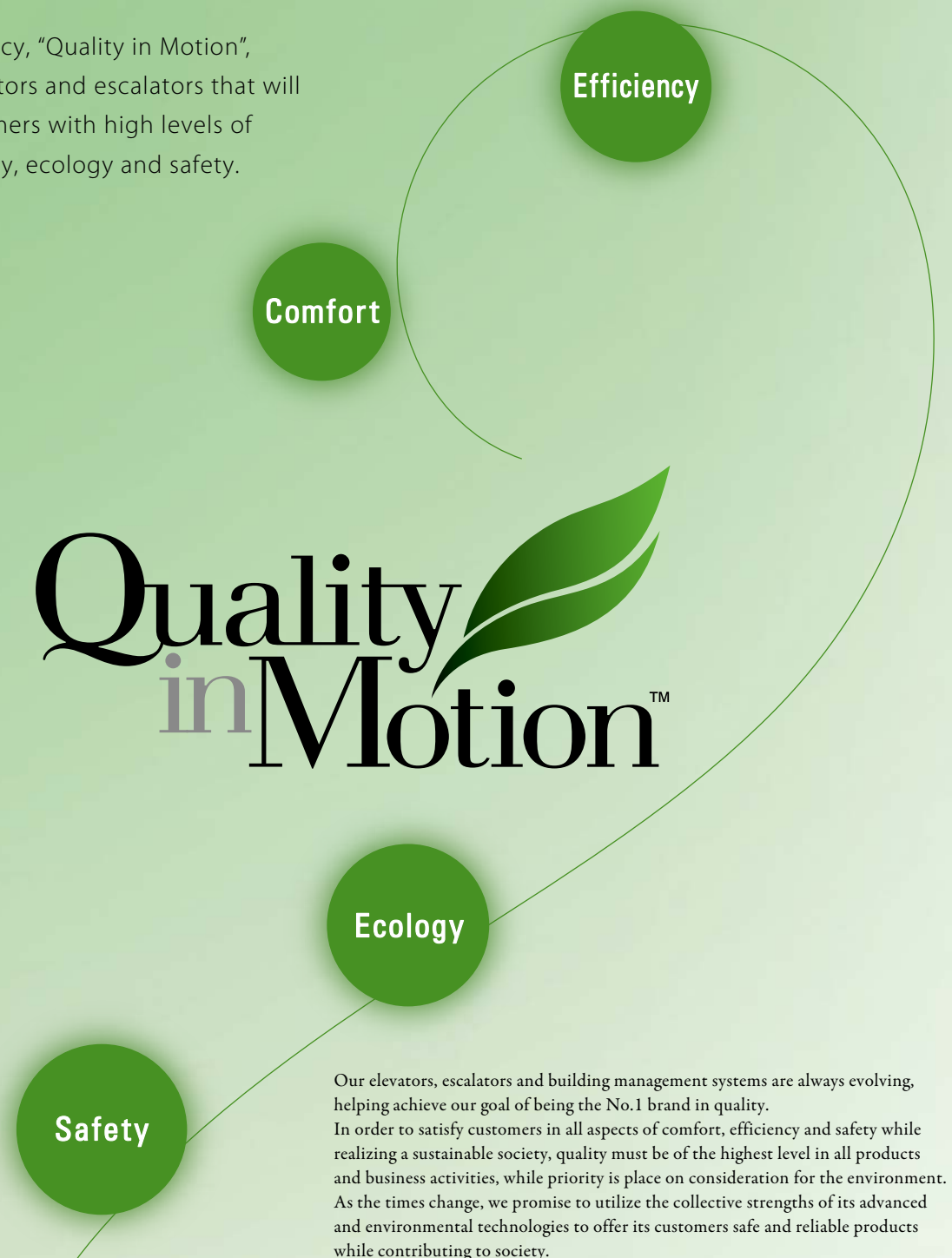

Safety

Ecology

Our elevators, escalators and building management systems are always evolving, helping achieve our goal of being the No.1 brand in quality. In order to satisfy customers in all aspects of comfort, efficiency and safety while realizing a sustainable society, quality must be of the highest level in all products and business activities, while priority is place on consideration for the environment. As the times change, we promise to utilize the collective strengths of its advanced and environmental technologies to offer its customers safe and reliable products while contributing to society.

We strive to be green in all of our business activities.

We take every action to reduce environmental burden during each process of our elevators' and escalators' lifecycle.



* Quality in Motion is a trademark of Mitsubishi Electric Corporation.



State-of-the-Art Factories... For the Environment. For Product Quality.

Our elevators and escalators are currently operating in approximately 90 countries around the globe. Built placing priority on safety, our elevators, escalators and building system products are renowned for their excellent efficiency, energy savings and comfort. The technologies and skills cultivated at the Inazawa Building Systems Works in Japan and 12 global manufacturing factories are utilized in a worldwide network that provides sales, installation and maintenance in support of maintaining and improving product quality. As a means of contributing to the realization of a sustainable society, we consciously consider the environment in business operations, proactively work to realize a low-carbon, recycling-based society, and promote the preservation of biodiversity.

ISO9001/14001 certification

Mitsubishi Elevator Asia Co., Ltd. has acquired ISO 9001 certification from the International Organization for Standardization based on a review of quality management. The plant has also acquired environmental management system standard ISO 14001 certification.



MITSUBISHI ELECTRIC BUILDING SOLUTIONS CORPORATION

HEAD OFFICE : TOKYO BLDG., 2-7-3, MARUNOUCHI, CHIYODA-KU, TOKYO 100-8310, JAPAN

www.MitsubishiElectric.com/elevator

⚠ Safety Tips: Be sure to read the instruction manual fully before using this product.

Revised publication effective Jul. 2022.
Superseding publication of C-CL1-0-CA602-A Nov. 2020.
Specifications are subject to change without notice.

©2022 Mitsubishi Electric Building Solutions Corporation